

ICEpower ICEmatch

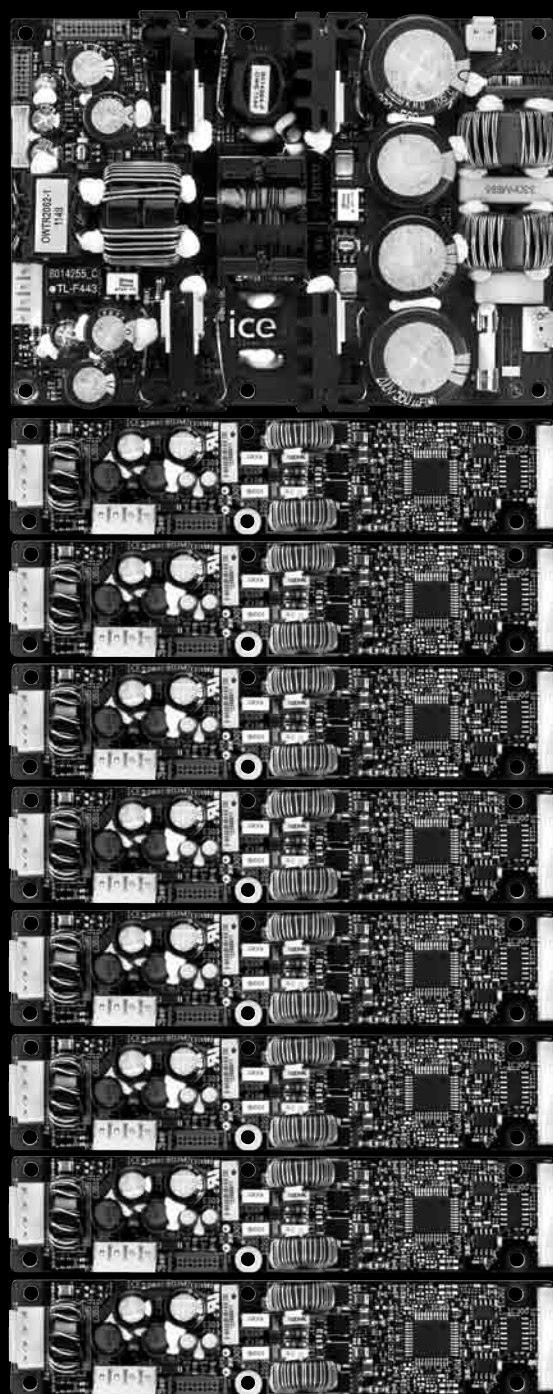

ICEmatch Size and Power

ICEpower400SM
400W audio power supply

True size

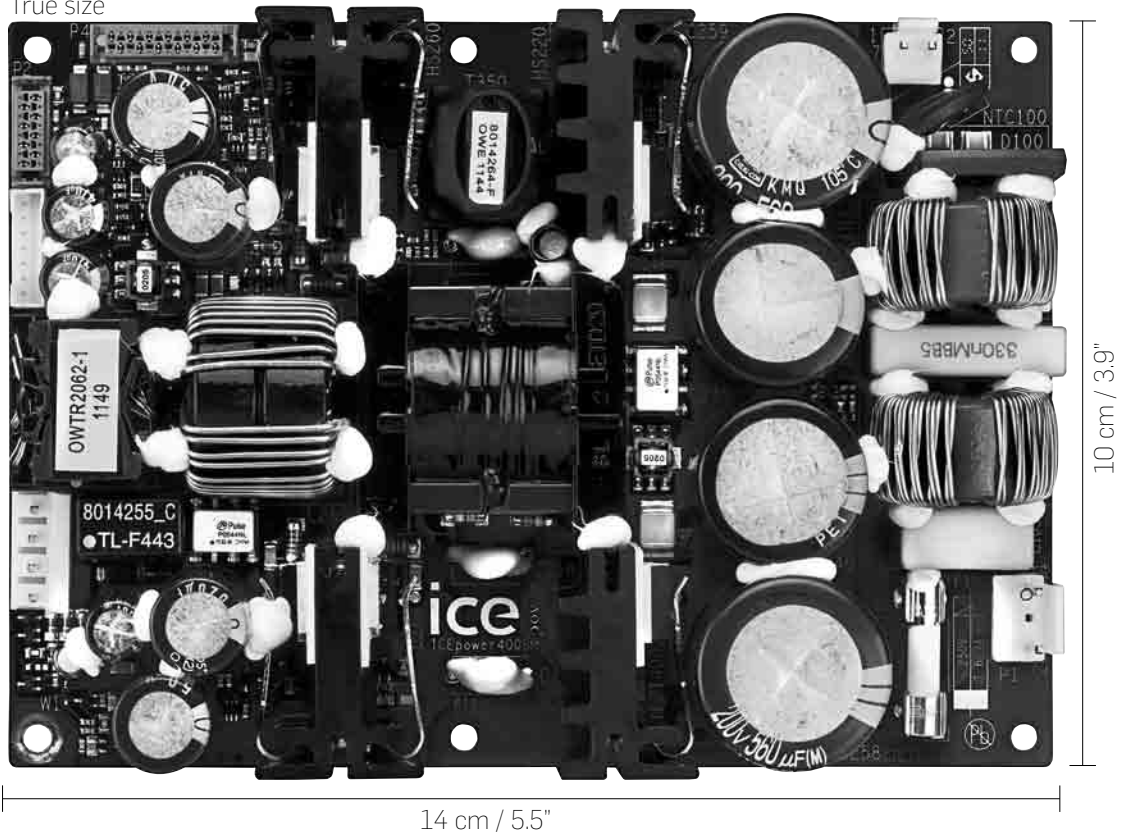

ICEpower80AM2
2 x 80W in 4Ω or 1 x 160W in 8Ω audio amplifier

True size

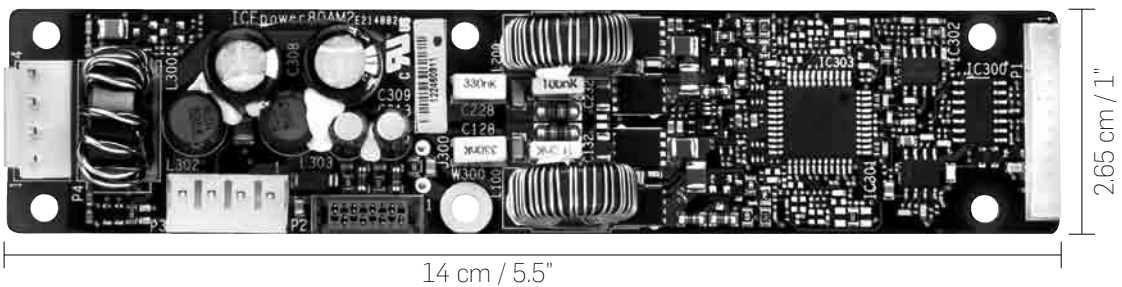

Dear Audio Manufacturer

Please allow us to make an assumption: You are reading this text because you plan to develop a high performance audio system. Now picture the design process ahead of you. Where do you prefer to place your focus? How do you wish to allocate your economic resources? How much time can you actually invest in the project? Developing high quality audio systems today is expensive and consumes large amounts of time and resources on factors that prolong the process instead of moving the project ahead. Why not leave those factors to us?

The purpose of our audio amplifier solutions is to make your design process as easy and cost effective as possible with no compromise to sound quality and product reliability. Leave the amplifier and power supply to us and you can concentrate on developing a desirable, differentiated audio product that will reach end-users faster.

Our newest amplifier solution guarantees exceptional sound quality, an unbelievably compact size, endless design possibilities and short time to market. The solution is called ICEmatch, a highly flexible plug-and-play solution that can realize everything from high performance active speakers to advanced multi-channel amplifiers with up to 16 channels.

The build quality is exceptionally solid and on top we have added all relevant protection features to ensure long-time usage and outstanding reliability in order to minimize your quality costs. Furthermore, to save you time and costs ICEmatch has been pre-approved for safety and EMC, simplifying the task of achieving certifications for your final product.

In order to reduce your stock level and to save you warehouse and logistics costs, ICEmatch is featured with a universal mains power supply, eliminating your need to stock both 115V and 230V mains product variants.

We have saved the best for last: The sound. ICEmatch is based on our proprietary HCOM Class D technology, which is unique in the sense that it incorporates not one, but two independent feedback loops: One from after the power stage and a second from after the output filter. This unique technology enables us to tailor each of the two feedback loops to deal with the specific issues related to the power stage and output filter independently, instead of having to make a compromise with a single feedback loop attempting to take care of both. Compared to other class D technologies, this results in overall lower distortion levels, less noise on the output, a frequency response that is less load dependant and a very low output impedance. So what does that translate to in terms of the sound? A natural, relaxed and dynamic sound with excellent stereo perspective and a tightly controlled precise bass that will do justice to any recording in your collection.

In fact, you have might already heard the ICEmatch as it amplifies the highly acclaimed Bang & Olufsen Beolab 12 speaker family?

We encourage you to experience ICEmatch yourself and we sincerely look forward to playing for you.

ICEmatch Overview

ICEmatch consists of two separate amplifier and power supply modules: The ICEpower400SM state-of-the-art 400W audio power supply and the powerful ICEpower80AM2 amplifier. One 400SM can power from one up to eight 80AM2 amplifiers, offering you endless design possibilities to develop everything from custom installation multi-channel amplifiers to home theatre receivers, active loudspeakers, studio monitors, steerable column speakers, etc.

The 400SM is a universal mains switch mode power supply with both +5V and +/- 12V auxiliary power supply, wake on signal sense, 12V trigger input and status LED indicators. It consumes less than 0.2W in standby and is therefore capable of supplying up to 0.3W to power your front end in standby, easily complying with EuP2013 standards.

The 80AM2 is a slim and light amplifier module which offers staggering audio performance despite its small size. Based on our HCOM modulation and control techniques, 80AM2 delivers crisp and clear audio in 2x 80W at 4Ω single ended or 1x 160W at 8Ω bridged (BTL).

Features

- Universal mains
- Standby functionality with wake-on-signal and trigger input
- Auxiliary power supplies , +5V and +-12V
- 2 x 80W at 4Ω single ended or 1 x 160W at 8Ω BTL mode
- Superb sound quality
- Comprehensive protection scheme
- Low profile – fits in a 1U rack

Application Convenience

The ability to bring new products to the market fast with a minimum of development investment required is key to surviving in an increasingly competitive global market.

Using an ICEpower amplifier and power supply module is a turn-key approach to product development that frees up your development resources to focus on developing the product features that truly differentiate your product rather than spending time on developing amplifiers and power supplies.

To deliver on this promise, ICEmatch is designed to require no additional heat sinking and is pre-approved for safety, EMC and RoHS compliance with all certificates available through ICEpower.

The fact that no upfront investments are required for product development means that using an ICEpower standard module secures cost competitiveness even at low manufacturing volumes.

Applications

With almost endless design possibilities and an ultra-compact design, ICEmatch is one of our most versatile audio amplifier systems yet. With one up to 16 channels achievable, a comprehensive range of protective features and an excellent build quality, the system is the evident choice for the following applications:

- Custom installation amplifiers
- Multi-channel amplifiers
- Steerable column speakers
- Active loudspeakers
- Studio monitors

See examples of applications on page 5-6

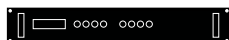

Application

Solution

4-way active speaker
2 x 80W at 4Ω
2 x 160W at 8Ω

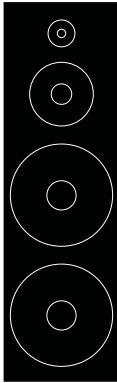

→ 1 x 400SM
3 x 80AM2*

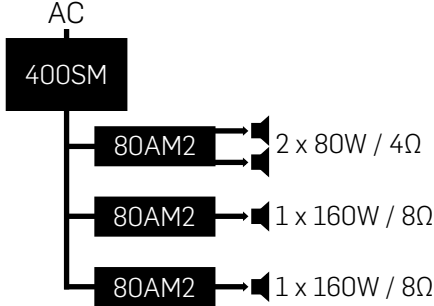

*ICEmatch amplifier solution in Bang & Olufsen Beolab 12-3 speaker

Steerable column speaker
14 x 80W at 4Ω



→ 1 x 400SM
7 x 80AM2

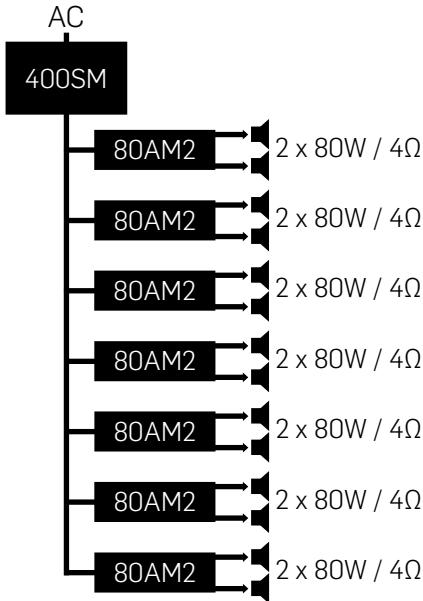

ICEpower400SM Power Supply

Incredible power does not necessarily mean bulky size – even with the possibility of 16 channels. This is more than proven with the ultra-compact 400SM and the benefits are obvious. Design freedom has been extended to the new levels as the 400SM with its 1U height fits perfectly even in very small cabinets which makes it easier to please today's design-focused customers. Furthermore, the low weight also means that freight costs will diminish, while resulting in an environment-friendlier foot print.

To keep your stock and logistics costs to a minimum, the 400SM power supply is a universal mains power supply, eliminating the need to stock both 115V and 230V versions of your product, thereby halving your necessary stock and saving you money.

The 400SM features separate $\pm 12V$ and +V auxiliary outputs for external use. These outputs can supply power for system control, DSP, microprocessors and preamp circuitry. This considerably simplifies the overall system design, saving you both cost and time.

400SM is equipped with a separate EuP2013 compliant 5V standby converter to supply external standby and control circuitry when the product is in standby mode. The standby converter has a wake-on-signal sense input as well as +5V and +12V trigger inputs, which can be used for bringing the 400SM from standby to active mode. The 400SM only consumes 200mW when in standby, leaving you up to 300mW to power your standby circuitry.

Furthermore, the 400SM includes LED drive and as the ICEpower80AM2 amplifiers are of the single ended output type, supply pump cancellation is implemented to avoid the need of huge decoupling capacitors.

A product that fails at the end user is expensive and time-consuming. The costs associated with loss of reputation, repairing, replacing or even recalling a product can be significant. Therefore, we have had a major focus on quality and protection during development. The 400SM implements the most advanced and comprehensive protection system we have implemented to date, with a total of 9 independent protection circuits monitoring temperatures, currents and voltages of several different functional blocks of the 400SM. Unbreakable is a strong word but we are close. This will keep your quality costs down and the music playing.

Feature Set Summary

Modular system with up to 16 channels	✓
Compact size with 1U height	✓
Up to 400W amplifier output power	✓
Universal Mains 85-264Vac	✓
Stand by consumption < 0.5W	✓
+/- 12V AUX supply	✓
+5V stand-by supply 200mA (stand by mode) / 1A (on mode)	✓
LED driver	✓
Comprehensive protection scheme (thermal, overload)	✓
Safety pre-approved, EMI approved	✓
Wake on signal	✓
12V trigger	✓

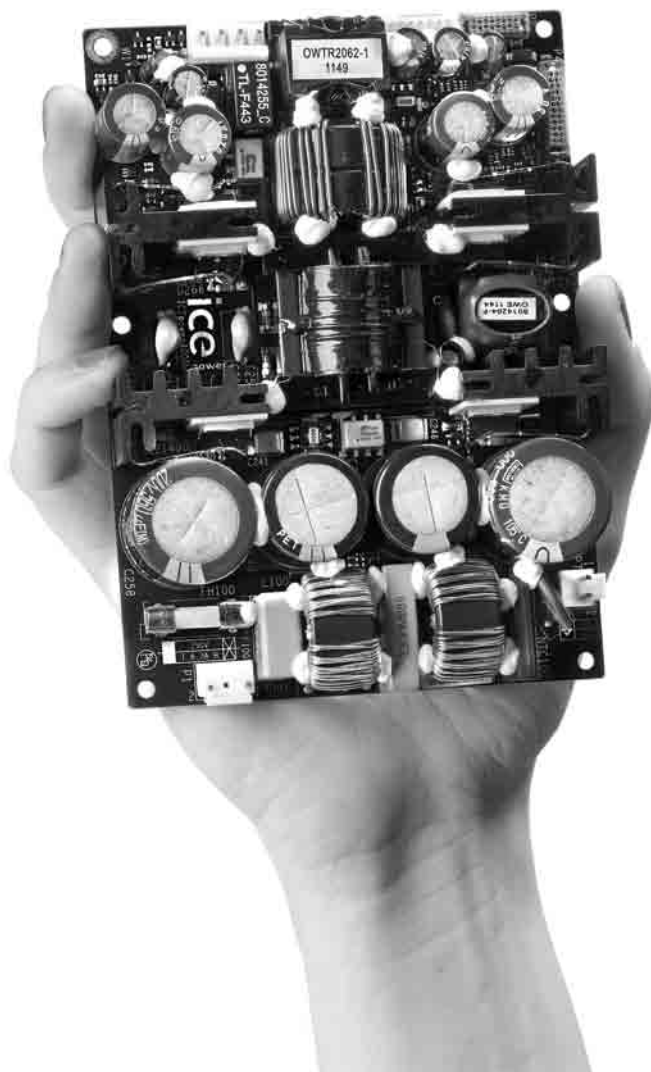

80AM2 Audio Amplifier

The ICEmatch audio amplifier, ICEpower80AM2, is smaller than a chocolate bar but it certainly has a lot more calories. It can output up to 2 x 80W in 4Ω Single Ended (SE) mode or 1 x 160W in 8Ω in Bridge-Tied-Load (BTL) configuration, enough power to give the listener a spectacular audio experience.

The ultra-compact design is easy to apply to your application and with its slim width and low profile it fits perfectly in confined spaces. This provides you with until now unseen design freedom and enables you to design a product that satisfies today's size-focused customers. The low weight and small size also take less space in your warehouse and is friendlier for the environment during transportation.

To keep quality costs to a minimum, the 80AM2 module implements a comprehensive protective system, which monitors temperature and output current of both the main power MOSFETs as well as the output zobel filter.

Using our patented HCOM class D technology, the amplifier is extremely power efficient and converts up to 94 % of the DC bus input to useful audio output. Listening to loud volumes suddenly got a lot greener.

In order to offer you a ready-to-implement product and save you time perfecting the sound, our engineers have done the job for you by spending months fine-tuning 80AM2's sound performance. The proprietary HCOM Class D technology incorporates not one, but two independent feedback loops: One from after the power stage and a second from after the output filter. This unique technology enables us to tailor each of the two feedback loops to deal with the specific issues related to the power stage and output filter independently, instead of having to make a compromise with a single feedback loop attempting to take care of both. Compared to other class D technologies, this results in overall lower distortion levels, less noise on the output, a frequency response that is less load dependant and a very low output impedance. So what does that translate to in terms of the sound? A natural, relaxed and dynamic sound with excellent stereo perspective and a tightly controlled precise bass that will do justice to any recording in your collection.

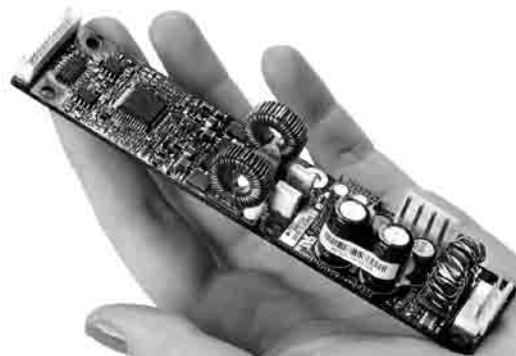

Feature Set Summary

Single ended or bridgable output (SE / BTL)	✓
Compact size with 1U height	✓
High power density	✓
Balanced input	✓
Soft clipping	✓
Overcurrent and thermal protection	✓
Pre-approved for Safety, EMC and RoHS	✓

Key Performance Parameters

Nominal power 0.1% THD+N, 20Hz < f < 20kHz	2 x 80W @ 4ohm SE 1 x 160W @ 8ohm BTL
Nominal power 1% THD+N, 1kHz	2 x 100W @ 4ohm SE 1 x 200W @ 8ohm BTL
Minimum load impedance	30hm
Maximum amplifier efficiency	94 %
Peak output current	20A
Dynamic range, SE	110 dB
Output referenced idle noise, SE (A-weighted)	45µV
THD+N 10W/1kHz	0.002 %
Upper bandwidth limit (-3dB) 80hm, SE	120kHz

THD+N vs. Output Power

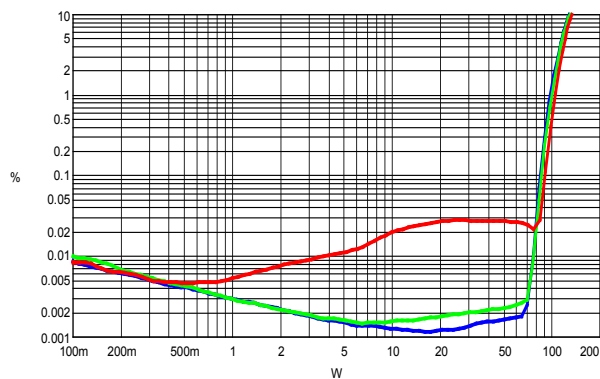

THD+N vs. Po at 100Hz, 1kHz, 6.67 kHz (4Ω), 230Vac/50Hz Single ended

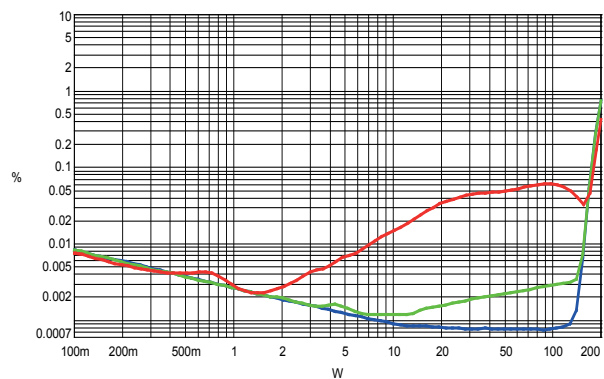

THD+N vs. Po at 100Hz, 1kHz, 6.67 kHz (8Ω), 230Vac/50Hz BTL mode

About ICEpower

ICEpower is an innovative Danish company developing and manufacturing energy efficient, high performance class D audio solutions for consumer, professional, automotive and portable audio applications. Our products are based on a range of innovative, proprietary technologies that deliver the best audio performance, efficiency and power density in the industry.

The company was founded in 1999 by Bang & Olufsen and Dr. Karsten Nielsen, based on the technologies developed in a joint research project between Bang & Olufsen and the Technical University (DTU), where Karsten Nielsen managed to achieve significant improvements in efficiency and audio quality of switching technologies. Today, ICEpower is a company of 40 employees and an independent subsidiary of Bang & Olufsen.

We are proud of the fact that ICEpower was one of the first companies to pioneer the audio industry's change from analogue technologies to highly efficient switching technologies, bringing about a true paradigm shift in the industry. Our technologies have raised the efficiency of audio amplifiers and power supplies from 50-70%, possible with traditional analogue technologies, to 80-95% – making audio devices "greener".

Today, we continue our focus on enhancing the efficiency, audio performance and power density in the audio power conversion chain. We work hard to stay on the forefront of technological development in our niche, continuously working to enhance our technological portfolio through in-house development, academic collaboration and partnerships with other industry players.

Since our establishment, we have cooperated with over 100 loyal customers and partners all over the world. Among them are some of the world's most respected companies, such as Bang & Olufsen, Bowers & Wilkins, Pioneer, TEAC, Samsung, ASUS Computers, Toshiba, Sanyo and Audi.

Please visit us at ICEpower.dk for further information about our products, our technologies and our company.

Europe (HQ)

ICEpower a/s
Gl. Lundtoftevej 1b
DK-2800 Kgs. Lyngby
Denmark

Tel. [45] 96 84 11 22
Fax [45] 96 84 57 99

info@icepower.dk
www.icepower.dk

North America

ICEpower America, Inc.
1751 Lake Cook Road, Suite 620
Deerfield, IL 60015
USA

Tel. [1] 847 590 4981
[1] 847 590 4983
Fax [1] 847 255 7805

Asia

ICEpower Japan K.K.
3F METLIFE Kabutocho Bldg.
5-1, Kabutocho Nihonbashi
Chuo-ku, Tokyo 103-0026
Japan

Tel. [81] 3 3780 8719
Fax [81] 3 5847 7901